

Standard Preparation 2000 mm Table with 3 +3 Drawers, Upstand & Sliding Doors

ITEM # _____

MODEL # _____

NAME # _____

SIS # _____

AIA # _____



133173 (NTA2010P)

Table with upstand 3+3 drawers and 2 sliding doors, 2000mm

Short Form Specification

Item No. _____

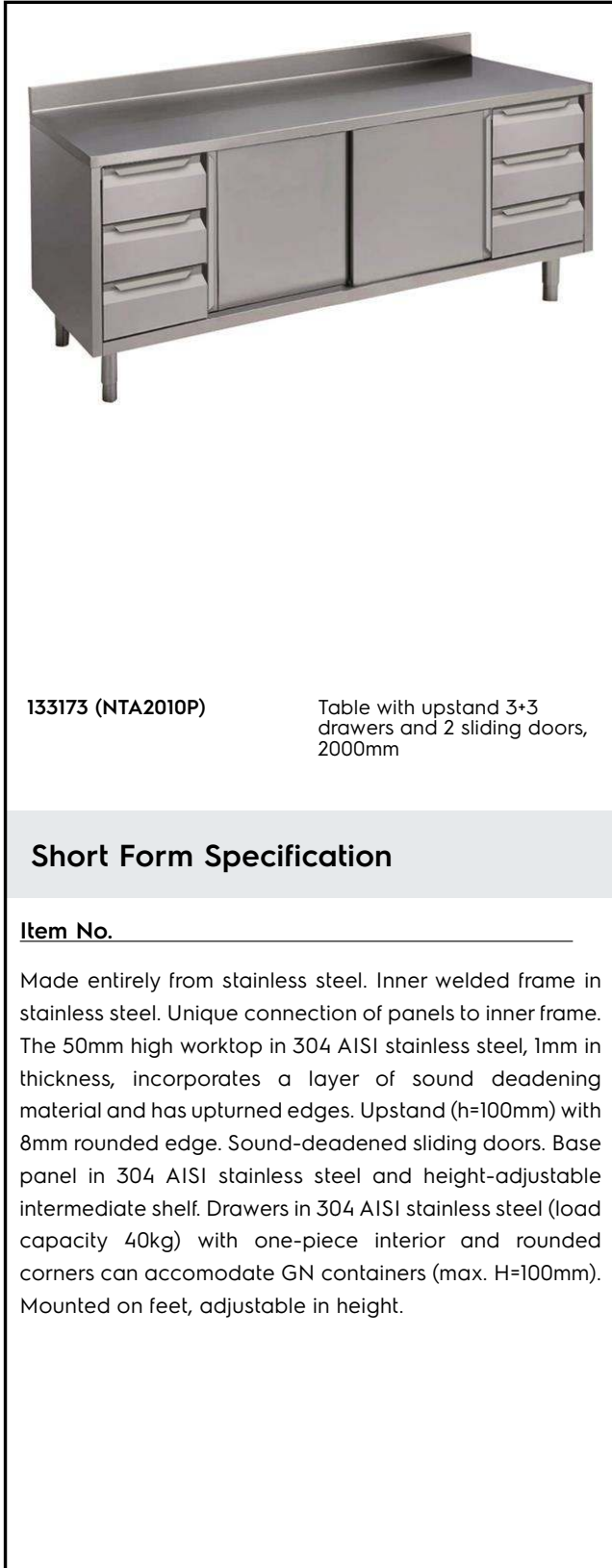
Made entirely from stainless steel. Inner welded frame in stainless steel. Unique connection of panels to inner frame. The 50mm high worktop in 304 AISI stainless steel, 1mm in thickness, incorporates a layer of sound deadening material and has upturned edges. Upstand (h=100mm) with 8mm rounded edge. Sound-deadened sliding doors. Base panel in 304 AISI stainless steel and height-adjustable intermediate shelf. Drawers in 304 AISI stainless steel (load capacity 40kg) with one-piece interior and rounded corners can accommodate GN containers (max. H=100mm). Mounted on feet, adjustable in height.

Main Features

- Sturdiness, stability and reliability of table accurately tested.

Construction

- 100 mm upstand with 8 mm radiused corner and 13 mm deep, designed to be used against a wall.
- 50 mm worktop in 304 AISI stainless steel with upturned edges, incorporates an 18 mm layer of sound deadening material.
- Reinforced side and base panel in 304 AISI stainless steel.
- Drawers in AISI 304 stainless steel with one-piece interior and rounded corners to facilitate cleaning and improve hygiene can hold GN containers with a maximum height of 100 mm. Maximum load capacity of 40 kg.
- Inner welded frame in stainless steel to guarantee superior strength and stability.
- Equipped with intermediate shelf which can be positioned at three different heights.
- Sturdy sound-deadened sliding doors on tracks located flush to the front of the frame.
- Easy access to the cupboard interior on all lengths guaranteed by the use of only 2 doors.
- Intermediate shelf in stainless steel with riveted corners and trasversal reinforcement in stainless steel.
- 100 mm upstand with 10 mm radiused corner and 13 mm deep, designed to be used against a wall.
- Base panel has 40mm high profile, is 8/10 in thickness with upturned edges and bar reinforcement. It is welded to legs for further structure reinforcement.
- 304 AISI stainless steel feet, 150 mm high and 54 mm in diameter, adjustable by -35/+25 mm.

Optional Accessories

- Wheel kit for cupboards, 4 wheels (2 with brakes), D=1000 mm PNC 855299

APPROVAL: _____

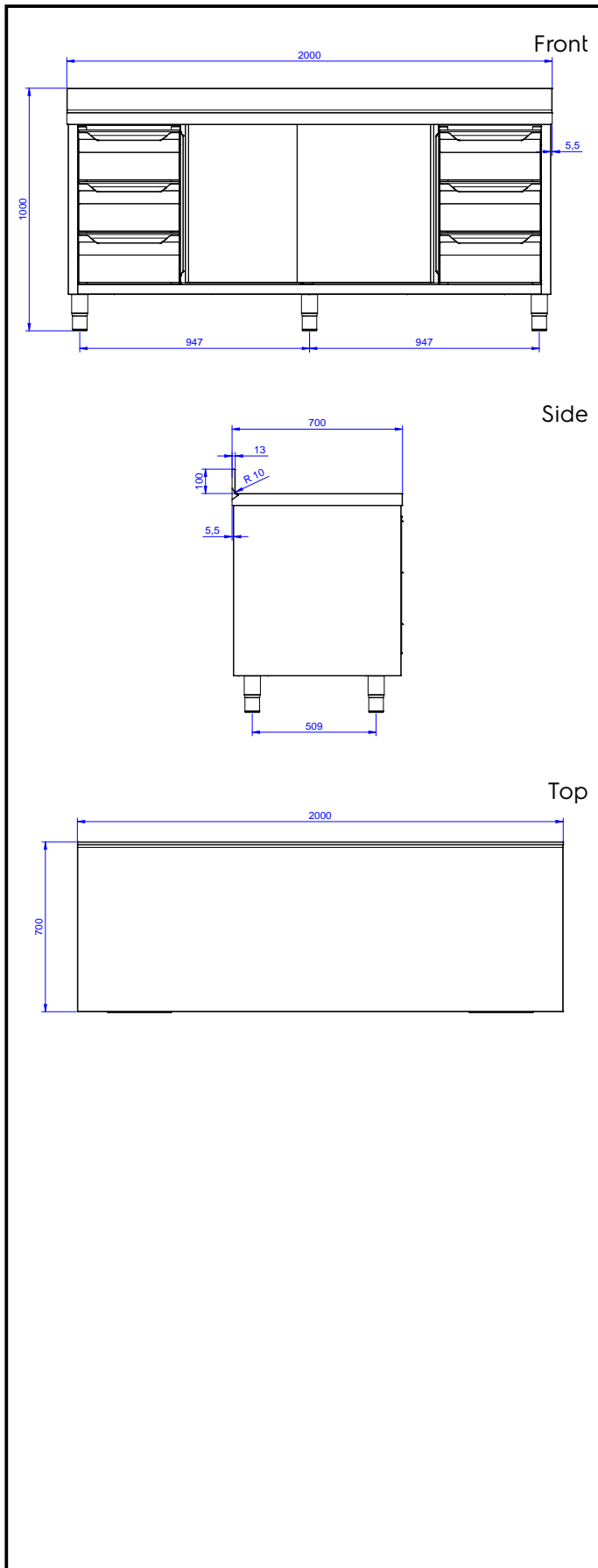

Key Information:

Cabinet width:		
133173 (NTA2010P)	1000 mm	
Cabinet depth:	645 mm	
Cabinet height:	610 mm	
External dimensions, Width:	2000 mm	
External dimensions, Depth:	700 mm	
External dimensions, Height:	1000 mm	
Upstand Dimensions, Height:	100 mm	
Upstand Dimensions, Depth:	13 mm	
Upstand Dimensions, Radius:	R=10	
Number and type of doors:	2 Sliding	
Worktop thickness:	50 mm	
Net weight:	85 kg	